

Combination Blanket/Fluid Warmer

EC1540BL



MN-47319

REV.01
1/21

EN



Manufacturer's Information

Copyright

© Copyright 1/21 by Entermics Medical Systems.

All rights reserved.

This manual or any portion thereof may not be reproduced or used in any manner whatsoever without the express written permission of Entermics Medical Systems.

Trademarks

All trademarks referenced in this documentation are the property of their respective owners.

Manufacturer



Entermics Medical Systems

An ISO 13485:2016 certified company

W164 N9221 Water Street

Menomonee Falls, WI 53051, USA

Original instructions

The content in this manual is written in American English.

Thank you for your Purchase!

This warmer has been thoroughly tested and inspected to ensure only the highest quality is provided. We supply the most durable, convenient, efficient and safe warming equipment on the market. All warmers are manufactured and fully inspected in the USA with a commitment to quality.

Register Your Warmer

Register

Register your Enthermics appliance online. Registering your appliance ensures prompt service in the event of a warranty claim. You will also receive direct notifications of software updates and additional product information.

Your personal information will not be shared with any other company.

www.enthermics.com/warranty-registration

Enthermics 24/7 Emergency Repair Service

Call

Call 800-558-8744 to reach our 24-hour emergency service call center for immediate access to local authorized service agencies outside standard business hours. The emergency service access is provided exclusively for Enthermics Medical Systems equipment and is available throughout the United States through Enthermics toll free number.

Availability

Emergency service access is available seven days a week, including holidays.

This page intentionally left blank.

Manufacturer’s Information 2

Foreword 3

 Thank you for your Purchase! 3

 Register Your Warmer 3

 Enthermics 24/7 Emergency Repair Service 3

Safety 7

 The Meaning of Signal Words 7

 Safety Precautions. 8

Labels 11

 Label Locations 11

Specifications 13

 Specification Information 13

 Dimension Drawings 14

Installation 15

 How to Unpack the Warmer 15

 How to Install the Warmer 16

Operation 17

 Preparing the Warmer for First Use. 17

 How to Turn On and Turn Off the Warmer. 18

 How to Operate the Blanket Warmer 19

 How to Use the Timer. 20

 How to Operate the Fluid Warmer 22

 How to Change the Temperature Scale. 24

 How to Change the Sound Settings 25

 How to Lock and Unlock the Controller. 26

Maintenance 27

 Maintenance Schedule 27

 How to Clean the Warmer 29

Troubleshooting 31

 What to do if the Warmer Malfunctions 31

 How to Manually Reset the Warmer 32

 Error Codes. 33

Warranty 37

 Warranty 37

TABLE OF CONTENTS

This page intentionally left blank.

The Meaning of Signal Words

This manual contains signal words where needed. These signal words must be obeyed to reduce the risk of death, personal injury, or equipment damage. The meaning of these signal words is explained below.

**DANGER**

Danger indicates a hazardous situation which, if not avoided, will result in serious injury or death.

**WARNING**

Warning indicates a hazardous situation which, if not avoided, could result in serious injury or death.

**CAUTION**

Caution indicates a hazardous situation which, if not avoided, could result in minor or moderate injury.

NOTICE

Notice indicates a situation which, if not avoided, could result in property damage.



NOTE: Note indicates additional information that is important to a concept or procedure.

Safety Precautions

Before you begin

Read and understand all instructions in this manual.

Electrical precautions

Obey these electrical precautions when using the warmer:

- Connect the warmer to a properly grounded outlet. Do not use the warmer if it is not properly grounded. Consult an electrician if there is any doubt that the outlet used is properly grounded.
 - Keep the cord away from hot surfaces.
 - Do not attempt to service the warmer or its cord and plug, when plugged in.
 - Do not operate the warmer if it has a damaged cord or plug.
 - Do not immerse the cord or plug in water.
 - Do not let the cord hang over the edge of a table or counter.
 - Do not use an extension cord.
-

Usage precautions

Obey these usage precautions when using the warmer:

- Only use this warmer for its intended use of warming medical solution bags, bottles, and/or blankets. Follow facility and solution manufacturer guidance regarding warming temperature for any item to be placed in the warmer.
 - Do not use this warmer for warming blood or blood products.
 - Do not cover or block any of the openings of this warmer.
 - Do not use this warmer in a wet location.
 - Only clean the warmer when the power cord is unplugged.
 - Do not use corrosive chemicals when cleaning the warmer.
 - Do not use the warmer cavity for storage.
 - Do not remove exterior panels from the warmer or attempt repairs. The warmer has no user-serviceable internal components. Only perform routine cleaning and maintenance procedures specifically described in this manual. Inspection and servicing of internal components must only be performed by qualified service personnel.
 - Only a qualified Enthermics service representative may make modifications to the warmer. Modifications to the warmer could be hazardous to users and patients.
-

Operator training

All personnel using the warmer must have proper operator training. Before using the warmer:

- Read and understand the operating instructions contained in all the documentation delivered with the warmer.
 - Know the location and proper use of all controls.
 - Keep this manual and all supplied instructions, diagrams, schematics, parts lists, notices, and labels with the warmer if the warmer is sold or moved to another location.
-

Operator qualifications

Only trained personnel with the following operator qualifications are permitted to use the warmer:

- Have received proper instruction on how to use the warmer.
 - Are familiar with the purpose, limitations, and associated hazards of the warmer.
-

The warmer must not be used by:

- People impaired by drugs or alcohol.
-

Condition of warmer

Only use the warmer when:

- All controls operate correctly.
 - The warmer is installed correctly.
 - The warmer is clean.
 - The warmer labels are legible.
-

Servicing the warmer

- Obey precautions in the manual, on tags, and on labels attached to or shipped with the warmer.
 - Only trained personnel are permitted to service or repair the warmer. Repairs that are not performed by a trained technician, or the use of non-factory parts, will void the warranty and relieve all liability.
 - Any troubleshooting guides and components views included with this manual are for reference only and are intended for use by qualified and trained service technicians.
 - To prevent serious injury, death or property damage, have the warmer inspected and serviced at least every twelve (12) months by a trained technician.
 - Contact Entermics for the authorized service partner in your area.
-

Incident notice

- Any serious incident that has occurred in relation to the warmer should be reported to the manufacturer and the competent authority of the Member State in which the user and/or patient is established.

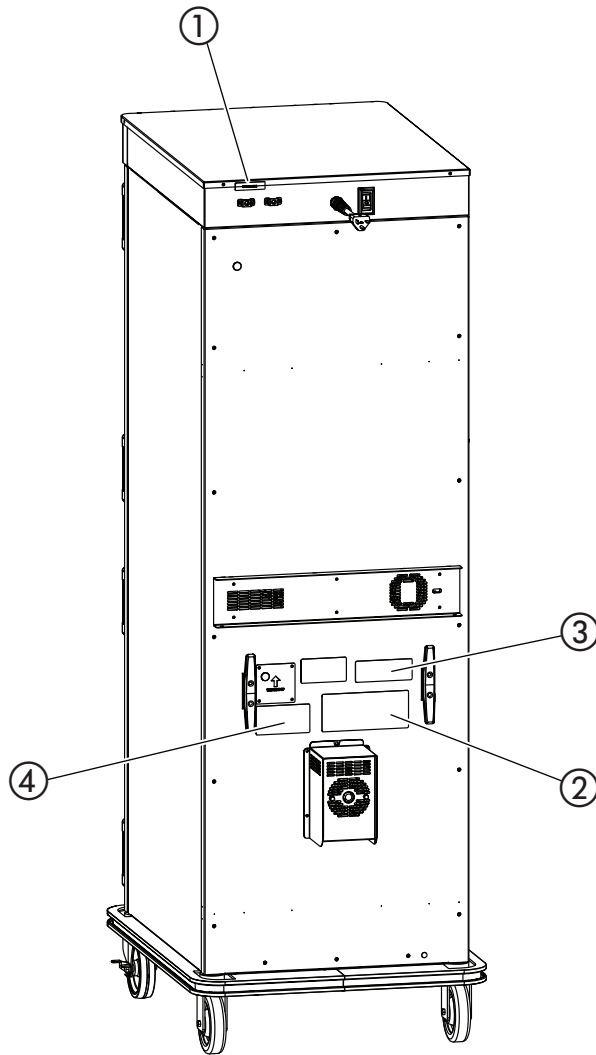

This page intentionally left blank.

Label Locations

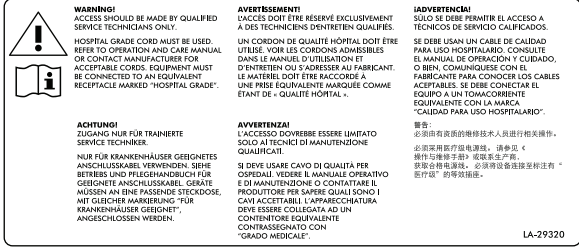

EC-PHD-011846

LABELS

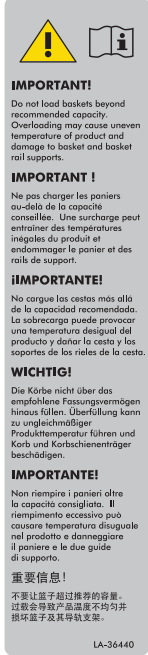
<p>1</p>		<p>Security seal</p>
<p>2</p>		<p>Electrical warning label</p>
<p>3</p>		<p>Enthermics contact information</p>
<p>4</p>		<p>Quality inspected</p>
<p>—</p>		<p>Do not load baskets beyond recommended capacity. Overloading may cause uneven temperature of product and damage to basket and basket rail support. (Inside of door)</p>

Specification Information

Model	EC1540BL
Intended use	Top cavity—warming blankets Bottom cavity—warming irrigation or injection fluids
Weight	Net: 374 lb (170 kg) Ship: 494 lb (224 kg)
Storage cavity capacity	Blanket cavity: 20–25 blankets (15.4 ft ³) Fluid cavity: 72 1-liter bags or 54 1-liter bottles
Temperature range	Blanket: 98°F to 180°F (37°C to 82°C) Irrigation fluid (IRR): 98°F to 150°F (37°C to 66°C) Injection fluid (INJ): 98°F to 104°F (37°C to 40°C)
Clearance requirements	3" (76mm) from rear 1" (25mm) from top 1" (25mm) from sides

Transportation and storage conditions

- Ambient temperature range of -40°F to +159°F (-40°C to +70°C).
- Relative humidity range of 10% to 95%, non-condensing.
- Atmospheric pressure range of 7.25 psi to 15.37 psi (50kPa to 106kPa).

Operating conditions

- The warmer must acclimate to the room temperature it will be placed in—24 hours is recommended.
- The recommended environmental temperature range is 60°F to 90°F (15°C to 32°C).
- The recommended relative humidity is above 20%, non-condensing.

Standards for electrical equipment

- Medical equipment listed by Underwriters Laboratories with respect to electrical shock, fire, and mechanical hazards only, in accordance with UL 60601-1 and CAN/CSA C22.2 No. 601.1.
- Grounding reliability can only be achieved when the appliance is connected to an equivalent receptacle marked "Hospital Grade."
- IP-XO ordinary



Dimension Drawings

EC1540BL

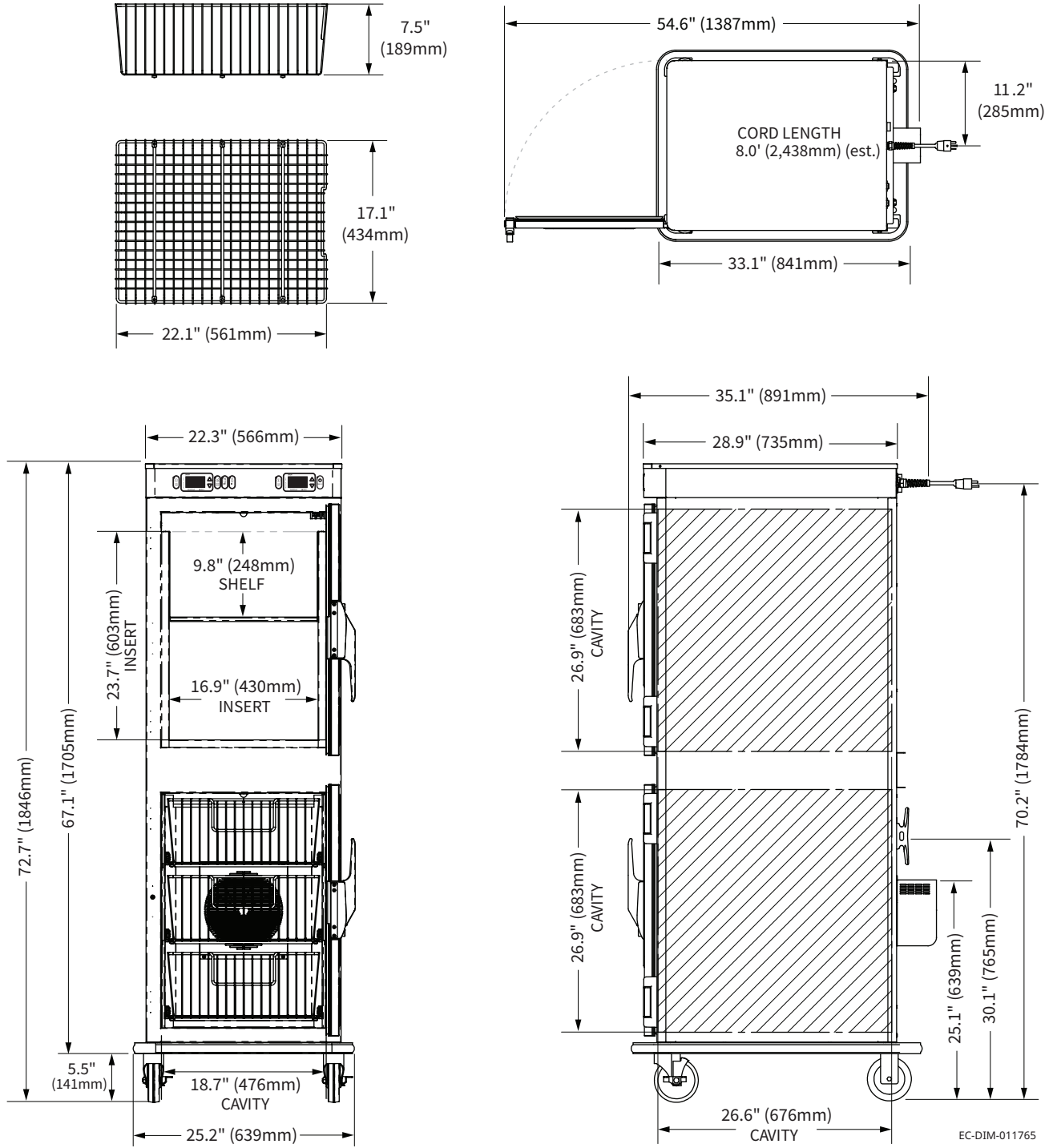

How to Unpack the Warmer



WARNING: Crushing hazard.

An unstable warmer can lead to a crushing hazard. Observe your facility's best practices for moving large equipment.

Before you begin

Make sure you have:

- Reviewed the warmer specifications.
- An appropriate lifting device and enough personnel to safely move and position the weight of the warmer.
- Cutting tools to remove the packaging.

Unpack the warmer

To unpack the warmer, do the following.

Step	Action
1.	<p>Remove the box or crate. Save all packing materials for inspection by the carrier.</p> <div style="border: 1px solid gray; padding: 5px; margin-top: 10px;"> <p>NOTE: Examine the warmer for damage. If the warmer has been damaged, do not use the warmer until it has been inspected by an authorized service provider. Contact your carrier or customer service.</p> </div>
2.	Cut and remove the retaining straps and plastic wrap.
3.	Remove the warmer from the pallet using an appropriate lifting device.
4.	Remove the paperwork from the cavity.

Result

The warmer is now unpacked.

How to Install the Warmer

Before you begin

Make sure you have:

An appropriate lifting device and enough personnel to safely move and position the weight of the warmer.

Requirements

- The warmer must be installed on a level surface.
- The warmer must not be installed in any area where it may be affected by steam, dripping water, high temperature, or any other severely adverse conditions.

Voltages

Model	V	Ph	Hz	kW
EC1540BL	120	1	50/60	1.92
	230	1	50/60	1.7

Position the warmer

To position the warmer, do the following.

Step	Action
1.	<p>Make sure that:</p> <ul style="list-style-type: none"> ■ The location where the warmer is being installed is rated to support the weight of the warmer; ■ The warmer is within five feet of the appropriate electrical outlet; ■ You follow the warmer clearance guidelines. Refer to topic <i>Specification Information</i> for clearance requirements.
2.	<p>Move the warmer to the installation location and onto the final resting surface.</p>
3.	<p>Lock the casters, if equipped.</p>

The warmer is now correctly positioned.

Connect power

To connect electric power to the warmer, do the following.

4.	<p>Connect the plug to the electrical outlet.</p>
----	--

Result

The warmer is now installed and ready to be used.

Preparing the Warmer for First Use

Before you begin



CAUTION: Burn hazard.
Allow the warmer to cool before cleaning.

NOTICE

Do not use:

- abrasive cleaning compounds.
- chloride based cleaners.
- commercial or household cleaners containing ammonia.

Procedure

To prepare the warmer for first use, do the following.

Step	Action
1.	Make sure that the warmer is turned off and cool.
2.	Wipe the outside of the warmer: <ul style="list-style-type: none"> ■ with a stainless steel cleaner, if stainless steel panels. ■ with an approved cleaning agent, if painted panels.
3.	Clean the interior of the warmer with a damp cloth or approved cleaning agent.
4.	Dry the interior and exterior of the warmer with a clean, lint-free cloth. Leave the door open until the interior of the warmer completely dries.
5.	Clean each side of the window pane with glass cleaner or distilled vinegar.

Result

The warmer is now ready for use.

How to Turn On and Turn Off the Warmer

Before you begin

The warmer must be connected to electric power.

Turning on the warmer

To turn on the warmer, do the following.

Step	Action
1.	Set the power switch ① to the ON (I) position.
	
2.	Press the ON/OFF button ①. The screen turns on.
<p>NOTE: A temporary odor may be noticeable upon initial start-up of the warmer. Contact the manufacturer if the odor persists after a day or more of continuous use.</p>	
<p>The warmer is now on.</p>	
<h2>Turning off the warmer</h2>	
<p>To turn off the warmer, do the following.</p>	
3.	Press and hold the ON/OFF button ① until the screen turns off, then release the button.
<p>NOTE: If equipped, the fan will continue to operate after the warmer is turned off using the ON/OFF button.</p>	
<p>The warmer is now off.</p>	

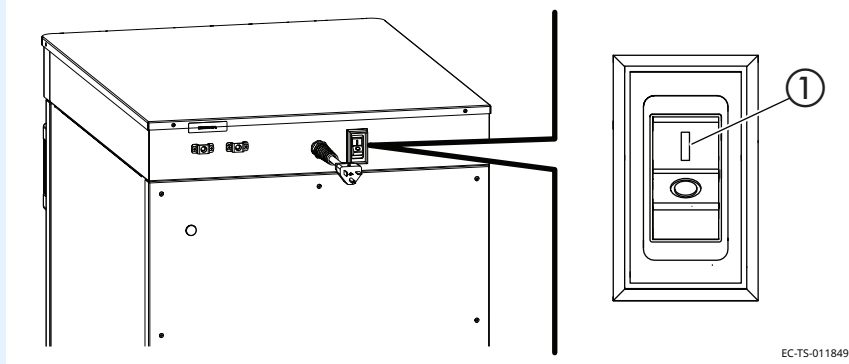

EC-TS-011849



NOTE: A temporary odor may be noticeable upon initial start-up of the warmer. Contact the manufacturer if the odor persists after a day or more of continuous use.

The warmer is now on.

Turning off the warmer

To turn off the warmer, do the following.



NOTE: If equipped, the fan will continue to operate after the warmer is turned off using the ON/OFF button.

The warmer is now off.

How to Operate the Blanket Warmer

Before you begin

The warmer must be connected to electric power and turned on.



WARNING: Personal injury hazard.

Do not operate the warmer in the presence of a flammable anesthetic mixture with air, oxygen, or nitrous oxide; in oxygen-enriched environments; or in any other potentially explosive environment.



WARNING: Personal injury hazard.

Make sure the blanket support assembly and shelves are installed to prevent the blankets from being scorched or discolored.





NOTICE

Do not overload the cavity.

Allow 1" (25mm) between the blankets and the interior walls.

Procedure

To operate the warmer, do the following.

Step	Action
1.	<p>Set the temperature using the arrow buttons  .</p> <p> NOTE: The temperature set-point range is 98°F – 180°F (37°C – 82°C).</p>
2.	<p>Open the door and load the dry, cotton blankets into the warmer. Close the door.</p> <p>NOTICE Do not warm items containing plastic, rubber, metal snaps, studs, hooks, etc.</p>
3.	<p>Press and hold the timer button  and the up arrow  at the same time.</p> <p>The actual temperature will display for five seconds. Then, the set-point temperature will display.</p>
4.	<p>Rotate the blankets daily from the bottom to the top of the load to ensure equal heating and to prevent discoloration.</p>

During the warming process

Result

The blankets are now warming.

How to Use the Timer

Before you begin





The warmer must be turned on (screen is on).

Background

The timer feature allows the user to program the controller to automatically turn on and off during a 24 hour period. This allows the warmer to turn off at night to save energy, then turn on automatically in the morning.

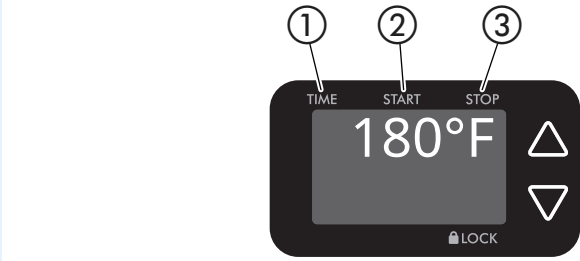
Setting the timer

To use the timer function, do the following.

Step	Action
1.	<p>Press and hold the TIMER button . The TIME icon ① illuminates.</p> 
2.	<p>Press the up and down arrow buttons   to change the time of day.</p> <p>NOTE: The screen displays the time of day in a 24-hour format (hh:mm).</p>
3.	<p>Press the TIMER button again. The START icon ② illuminates.</p> <p>Press the up and down arrow buttons to change the start time.</p>
4.	<p>Press the TIMER button again. The STOP icon ③ illuminates.</p> <p>Press the up and down arrow buttons to change the stop time.</p> <p>NOTE: Make sure the start and stop times are different. The timer will not operate if both times are the same.</p>
5.	<p>Press the TIMER button again to enable the timer.</p> <p>The time status LED indicator  illuminates.</p>

Continued on next page

Continued from previous page

Disabling the timer

6. **Press and hold** the TIMER button until the timer status LED indicator goes out.

Result

The timer has now been enabled or disabled.

How to Operate the Fluid Warmer

Before you begin

The warmer must be connected to electric power and turned on.



WARNING: Personal injury hazard.

Do not operate the warmer in the presence of a flammable anesthetic mixture with air, oxygen, or nitrous oxide; in oxygen-enriched environments; or in any other potentially explosive environment.



WARNING: Personal injury hazard.

Verify the fluid temperature prior to using the fluid. Refer to the fluid manufacturer's label for recommended warming procedures.

Do not use any fluids that are warmed above the suggested temperature.





NOTICE

Do not overload the cavity.

Refer to topic *Specification Information* for the storage cavity capacity.

Procedure

To operate the warmer, do the following.

Step	Action
1.	<p>Select the operation mode.</p> <ul style="list-style-type: none"> Press the irrigation button  for irrigation mode. Press the injection button  for injection mode. <p>To change between irrigation mode and injection mode, turn the screen off and then back on.</p> <p>NOTE: Open the door to cool the cavity before changing from a higher temperature to a lower temperature.</p>
2.	<p>Set the temperature using the arrow buttons  .</p> <p>NOTE: The irrigation temperature set-point range is 98°F - 150°F (37°C - 66°C). The injection temperature set-point range is 98°F - 104°F (37°C - 40°C).</p>

Continued on next page

Continued from previous page

During the warming process

3. **Open** the door and load the fluid into the warmer.
Close the door.

4. **Press and hold** the over temp button  and the up arrow  at the same time.

The actual temperature will display. Then, the set-point temperature will display.

Result

The fluids are now warming.





How to Change the Temperature Scale

Before you begin

The warmer must be connected to electric power and the screen turned off.

Procedure

To change the temperature scale from °F to °C and vice versa, do the following.

Step	Action
1.	Press and hold the ON/OFF button  until the screen turns off, then release the button.
2.	Press and hold the up arrow button  until the warmer beeps and displays the temperature scale, then release the button.
3.	Press the up and down arrow buttons   to toggle between the temperature scales.
4.	Press the ON/OFF button  to set the temperature scale.

Result

The temperature scale has now been changed.







How to Change the Sound Settings

Before you begin

The warmer must be connected to electric power and the screen turned off.

Procedure

To change the sound settings, do the following.

Step	Action
1.	Press and hold the ON/OFF button  until the screen turns off, then release the button.
2.	Press and hold the down arrow button  until the warmer beeps and displays the sound setting of 0 or 1, then release the button.
3.	Press the up and down arrow buttons   to turn the sound on or off.
<p> NOTE: Setting the sound to 0 turns the sound off. Setting the sound to 1 turns the sound on.</p>	
4.	Press the ON/OFF button  to set the sound setting.

Result

The sound setting has now been changed.

How to Lock and Unlock the Controller

Before you begin

The warmer must be turned on (screen is on).

Background

The controller can be locked to prevent changes being made to the temperature set-point.

Locking the controller

To lock the controller, do the following.

Step	Action
1.	<p>Press and while holding the ON/OFF button , press the up arrow button .</p> <p>The lock indicator  LOCK will illuminate.</p> <p>NOTE: Make sure the set-point temperature did not change during the locking process.</p>
2.	<p>Press and while holding the ON/OFF button , press the down arrow button .</p> <p>The lock indicator  LOCK goes off.</p> <p>NOTE: Make sure the set-point temperature did not change during the locking process.</p>



Unlocking the controller

To unlock the controller, do the following.



Result

The controller has now been locked or unlocked.

Maintenance Schedule



NOTE: Do not remove exterior panels from the warmer or attempt repairs. The warmer has no user-serviceable internal components. Only perform routine cleaning and maintenance procedures specifically described in this manual.

Daily

For daily maintenance, do the following.

Check:

- the air vents in the airflow insert panels are not obstructed (if applicable).
- all fan guards are clear and not obstructed (if applicable).
- the number of bottles/bags, or blankets as applicable do not exceed the maximum capacity per shelf or basket.

Clean:

- any spills with a clean, lint free cloth. See topic *How to Clean the Warmer* for the list of approved cleaners.

Monthly

For monthly maintenance, do the following.

Check:

- the door gasket for tears and holes. Make sure that it is firmly attached to the door. Check the seal when the door is closed.
- the guards around the air temperature sensor are in place and fully secure to the warmer.
- the hardware securing the warmer(s) to the wall, if applicable.

Clean:

- the outside of the warmer with stainless steel cleaner. See topic *How to Clean the Warmer* for the list of approved cleaners.
- vacuum (if applicable):
 - fan openings
 - fan sail switch
 - vent openings

Continued on next page

MAINTENANCE

Continued from previous page

Yearly

For yearly maintenance, do the following.

Check:

- the set-point temperature compared to the actual temperature displayed.
 - Check the cavity air temperature with a thermocouple placed 1" (25mm) from the cavity sensor. Do not allow the thermocouple to touch any surface. Monitor the temperature for approximately one hour in an empty cavity.
- the condition of the plug and cord and replace if damaged.
- the controller screen for excessive wear. Make sure the controller screen displays and operates properly.

Clean:

- the shelves and interior of the warmer. See topic *How to Clean the Warmer* for the list of approved cleaners.

How to Clean the Warmer

Before you begin



WARNING: Electric shock hazard.
Disconnect the warmer from electric power before cleaning.



CAUTION: Burn hazard.
Allow the warmer to cool before cleaning.

NOTICE

Do not use:

- abrasive cleaning compounds.
- chloride based cleaners.
- commercial or household cleaners containing ammonia.
- cleaners containing quaternary salts.

Monthly cleaning procedure

To clean the warmer monthly, do the following.

Step	Action
1.	Make sure that the warmer is disconnected from electric power and cool.
2.	Wipe the outside of the warmer with a stainless steel cleaner.
3.	Vacuum lint from fan openings, fan sail switch, and vent openings (if applicable).
4.	Clean the interior of the warmer with a damp cloth.
5.	Dry the interior and exterior of the warmer with a clean, lint-free cloth. Leave the door open until the interior of the warmer completely dries.
6.	Clean each side of the window pane with glass cleaner or distilled vinegar.

Continued on next page

Yearly cleaning procedure

Continued from previous page

To clean the warmer yearly, do the following.

Step	Action
------	--------

1.	Make sure that the warmer is disconnected from electric power and cool.
----	--

2.	Remove the shelves, baskets, and support assembly from the interior of the warmer.
----	---

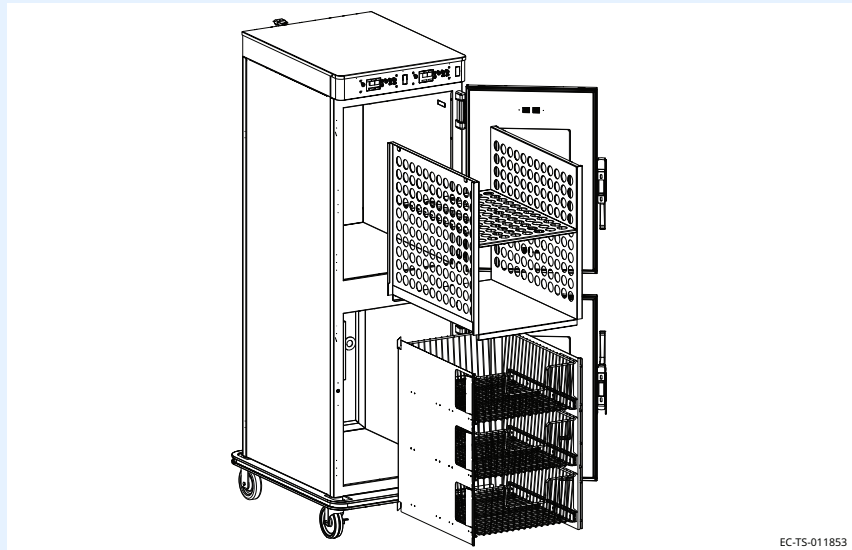

EC-T5-011853

3.	Clean the shelves, baskets, support assembly and interior with a damp cloth.
----	---

4.	Dry the interior of the warmer with a clean, lint-free cloth. Leave the door open until the interior of the warmer completely dries.
----	---

5.	Clean each side of the window pane with glass cleaner or distilled vinegar.
----	--

6.	Re-install the shelves, baskets, and support assembly.
----	---



WARNING: Personal injury hazard.

The blankets may overheat if the shelves and support assembly are not in place. Make sure to re-install the shelves and support assembly before operating the warmer.

Result

The warmer is now clean.

What to do if the Warmer Malfunctions

Background The controller sounds an alarm and the screen displays an error code when the warmer malfunctions.

Procedure If the warmer malfunctions, do the following.

Step	Action
1.	<p>Press the ON/OFF button  to acknowledge the alarm.</p> <p>Refer to the troubleshooting section for the error code.</p>
2.	Make sure the fluids and blankets are the correct temperature before using.

Result Resume operation of the warmer.

How to Manually Reset the Warmer

Background

In the case of overtemperature, a high limit switch will disable the heating function. The warmer can be manually reset using the high limit manual reset button(s) located at the rear of the warmer.

Procedure

To manually reset the warmer, do the following.

Step	Action
1.	Press the high limit manual reset button(s) ①.

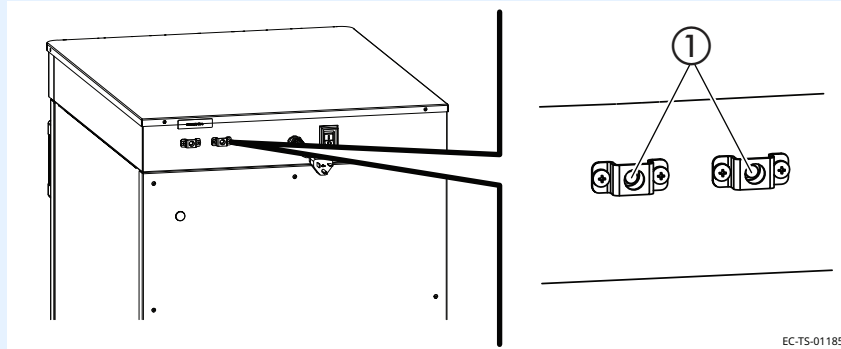

EC-TS-011857



NOTE: If the manual reset warmer button(s) trips again while the warmer is operating, contact Enthermics for the authorized service partner in your area.

Result

Resume operation of the warmer.

Error Codes

Background

This section is provided for the assistance of qualified and trained service technicians only and is not intended for use by untrained or unauthorized service personnel. Failure to observe this precaution may void the warranty.

i **NOTE:** If the warmer is not operating properly, check the following before calling an authorized service agent:

Verify that the power to the warmer is on.

If applicable, ensure the female end of plug is securely seated in the warmer and that the male end of plug is in an appropriate, functioning outlet.

If applicable, examine the fuses. Replace the fuses, refer to topic *How to Replace a Fuse*.

If applicable, examine the high limit manual reset button. If the high limit manual reset button is tripped, reset the warmer, refer to topic *How to Manually Reset the Warmer*.

i **NOTE:** All non-critical codes can be cleared using the standby button. Critical errors (marked with a *) can only be cleared by setting the power switch at the rear of the warmer to the off (O) position and allowing the warmer to cool.

NOTICE Do not attempt to repair or service the warmer beyond this point. Contact the manufacturer for the nearest authorized service agent. Repairs made by any other service agent without prior authorization by the manufacturer will void the warranty.

Code	Refers to	Action required
Display flashes set point	Cavity temperature higher than set point	<p>Cavity temperature is higher than the set point temperature.</p> <ul style="list-style-type: none"> Allow cavity to cool to set point temperature.
E-10 ES10 ES20 ES30 ES40 ES50 ES60 ES70	Cavity sensor Sensor 1 Sensor 2 Sensor 3 Sensor 4 Sensor 5 Sensor 6 Sensor 7	<p>Sensor is shorted. Software disengages heating pads. Acknowledge error by pressing the standby button. If error persists, a qualified service technician should test the sensor.</p> <ul style="list-style-type: none"> Test the sensor. Detach the sensor from the warmer. Use an Ohm meter to measure the resistance of the sensor. Check the sensor at 25°C (77°F). If the reading is 10 KOhm ±1.5 KOhm, replace the display. If the reading is ±2 KOhm, replace the sensor. Check the wires for integrity. Inspect the connections at the control and terminal block to ensure proper and secure connections. If necessary, re-secure the faulty connections. Contact service if error persists.

Code	Refers to	Action required
E-11 ES11 ES21 ES31 ES41 ES51 ES61 ES71	Cavity sensor Pad sensor 1 Pad sensor 2 Pad sensor 3 Pad sensor 4 Pad sensor 5 Pad sensor 6 Pad sensor 7	<p>Sensor is open. Software disengages heating pads. Acknowledge error by pressing the standby button. If error persists, a qualified service technician should test the sensor.</p> <ul style="list-style-type: none"> ■ Test the sensor. Disconnect the sensor from the warmer control PCB and use an Ohm meter to measure the resistance of the sensor. Sensor PR-37140 should measure 10 KOhm \pm 1.5 KOhm at 25°C (77°F). Sensor SN-33541 should measure 100 Ohm \pm 10 Ohm at 25°C (77°F). Replace sensor if measurement is outside of tolerance. ■ Check the wires for integrity. Check for proper and secure connections at the control and terminal block. If necessary, re-secure the faulty connections. ■ Contact service if error persists.
E-30	Under temperature	<p>The cavity temperature is lower than the set temperature for 90 minutes or longer.</p> <ul style="list-style-type: none"> ■ Make sure the door is closed. ■ If the cavity is overloaded, redistribute the inventory. Do not exceed the height of the insert. ■ Test the sensor. Disconnect the sensor from the warmer control PCB and use an Ohm meter to measure the resistance of the sensor. Sensor PR-37140 should measure 10 KOhm \pm 1.5 KOhm at 25°C (77°F). Sensor SN-33541 should measure 100 Ohm \pm 10 Ohm at 25°C (77°F). Replace sensor if measurement is outside of tolerance.
*E-31	Cavity sensor	<ul style="list-style-type: none"> ■ The sensor reading is above the temperature set-point. Blanket warming mode triggers at 15° over set-point. Fluid warming mode triggers at 5° over set-point. ■ The difference between the room temperature and the fluid set-point temperature must be greater than 11°C (20°F). ■ Contact service if error persists.
P131 P231 P331 P431 P531 P631 P731	Pad sensor 1 Pad sensor 2 Pad sensor 3 Pad sensor 4 Pad sensor 5 Pad sensor 6 Pad sensor 7	<p>Heater pad over-temp error.</p> <ul style="list-style-type: none"> ■ Software disengages heating pads. ■ Acknowledge error by pressing the standby button. ■ Allow the warmer to cool. ■ Contact service if the error persists.
*E-33	Cavity sensor	<ul style="list-style-type: none"> ■ Sensor reading is above maximum allowable temperature set-point and over temp value. Blanket warmers trigger at 82°C (180°F). Fluid warmers trigger at 71°C (160°F). ■ Contact service if error persists.
*E-50	Analog to Digital Converter Error	<ul style="list-style-type: none"> ■ Remove inventory, discard if necessary, and allow the warmer to cool down. ■ If error persists after cool down and reset, the control assembly should be replaced by a qualified service technician. Contact service.

Code	Refers to	Action required
E-60	Real Time Clock Checksum Error (Blanket warmers only)	Real time clock rechargeable battery backup has discharged. <ul style="list-style-type: none"> ■ Plug the warmer into the outlet for 30 minutes.
*E-61	Real Time Clock (Blanket warmers only)	Real time clock not responding. Contact service if error persists.
E-62	Real Time Clock (Blanket warmers only)	Timer overlay is present, but no real time clock is detected. Contact service.
*E-70	Pad Count Error	More heater pads detected than set for. Hold the standby button for 12 seconds until display shows "PAd#" (# = number of pads selected [3-7]). Press up or down arrow to adjust to correct number of pads. [Blanket warmers: 1.5ft ³ , 2.5ft ³ = 3 pads, 3.5ft ³ , 4.0ft ³ , 7.5ft ³ = 4 pads. Fluid warmers: 2.5ft ³ & 4.0ft ³ = 3 pads].
*E-71	Personality Error	Contact service.
E-80	EEPROM Error	EEPROM not responding. Contact service if error persists.
*E-81	Calibration not locked	Contact service.
*E-83	EEPROM Error	Contact service for help resetting the control.
E-87	EEPROM Error	Stored offsets corrupted. Offsets reset to 0. <ul style="list-style-type: none"> ■ Control may need to be re-calibrated. ■ Possible bad EEPROM. ■ Contact service if error persists.
E-90	Button stuck	A button has been held down for >60 seconds. Adjust control. Error will reset when the problem has been resolved.
E-95	Factory Test pin short detected.	Ensure that debris is not causing a short between the test pins. If the pins are clean, replace the control.
*E-98	Temperature Delta Error	Temperature of the cavity sensors 1 and 2 differ by more than 3.3°C (6°F). <ul style="list-style-type: none"> ■ Remove product and allow the warmer to cool down. ■ Verify that the product sensor is clean and operating correctly. ■ Set the power switch to the OFF position to clear the error code. ■ If error persists, the cavity sensor should be replaced by a qualified service technician. Contact service.
E-99	Hardware Over Temp	<ul style="list-style-type: none"> ■ Inspect the connections and condition of high limit bimetal thermostat. ■ If applicable, make sure that the compartment fan motor is operating. ■ Contact service if error persists.

TROUBLESHOOTING

Code	Refers to	Action required
*EFAn	Fan or Fan Sensor Failure	<ul style="list-style-type: none"> ■ Check to make sure the fan sensor wires did not disconnect from the fan or the control board. ■ If the error persists after checking the wires, replace the fan.
Flashing yellow iv fluid temperature status indicator	Flashing yellow LED is illuminated within iv storage shelf	<ul style="list-style-type: none"> ■ Set the power switch to the OFF position. ■ Remove any iv bags from inside the warmer. ■ Set the power switch to the ON position. ■ Visually check to see if flashing yellow LED remains illuminated. ■ Contact service if error persists.

*All non-critical codes can be cleared using the standby button. Critical errors (marked with a *) can only be cleared by setting the power switch at the rear of the warmer to the OFF position and allowing the warmer to cool.

Warranty

Introduction

Enthermics Medical Systems warrants to the original purchaser only, that any original part found to be defective in material or workmanship will be replaced with a new or rebuilt part at Enthermics option, subject to provisions hereinafter stated.

Warranty Period

The warranty period is as follows:

- For warming cabinets shipped to the United States or Canada,
 - The labor warranty remains in effect for one (1) year from installation or fifteen (15) months from the shipping date, whichever comes first. Enthermics will bear normal labor charges performed during the standard business hours, excluding overtime, holiday rates or any additional fees.
 - The original parts warranty remains in effect five (5) years from installation of appliance or sixty-three (63) months from the shipping date, whichever comes first.
- For warming cabinets shipped outside of the United States or Canada,
 - The original parts warranty is one (1) year from the date of installation of appliance or fifteen (15) months from the shipping date, whichever comes first.
- To be valid, a warranty claim must be asserted during the applicable warranty period. This warranty is not transferable.

Exclusions

This warranty does not apply to:

- Calibration.
- Equipment damage caused by accident, shipping, improper installation or alteration.
- Equipment used under conditions of abuse, misuse, carelessness or abnormal conditions, including but not limited to, equipment subjected to harsh or inappropriate chemicals, including but not limited to, compounds containing chloride or quaternary salts, poor water quality, or equipment with missing or altered serial numbers.
- Any losses or damage resulting from malfunction, including the loss of contents or consequential or incidental damages of any kind.
- Equipment damage caused by use of any cleaning agents other than those recommended by Enthermics, including but not limited to damage due to chlorine or other harmful chemicals.
- Equipment modified in any manner from original model, substitution of parts other than factory authorized parts, unauthorized removal of any parts including legs, or unauthorized addition of any parts.

Continued on next page

Continued from previous page

- Collateral or incidental damage as a direct result of servicing equipment built into a wall structure is not covered under warranty. It is the responsibility of the owner to bear all expense related structural repairs including, but not limited to, external electrical connections and wiring, and the removal or replacement of caulk, grout, tile, or wall covering of any kind. A service access panel for built-in equipment installations is strongly recommended.

Conclusion

This warranty is exclusive and is in lieu of all other warranties, express or implied, including the implied warranties of merchantability and fitness for a particular purpose. No person except an officer of Enthermics is authorized to modify this warranty or to incur on behalf of Enthermics any other obligation or liability in connection with Enthermics equipment.



Printed in the U.S.A.

Specifications are subject to change without notice.

Enthermics Medical Systems
An ISO 13485:2016 certified company
W164 N9221 Water St
Menomonee Falls, WI 53051
262-251-8356 | 800-TO-B-WARM
generalinfo@enthermics.com
www.enthermics.com

Made in the U.S.A